

# **TENSION TEST STAND**

## **Verification and Calibration Procedures**

### **FSU2A155B FSU2A150B**

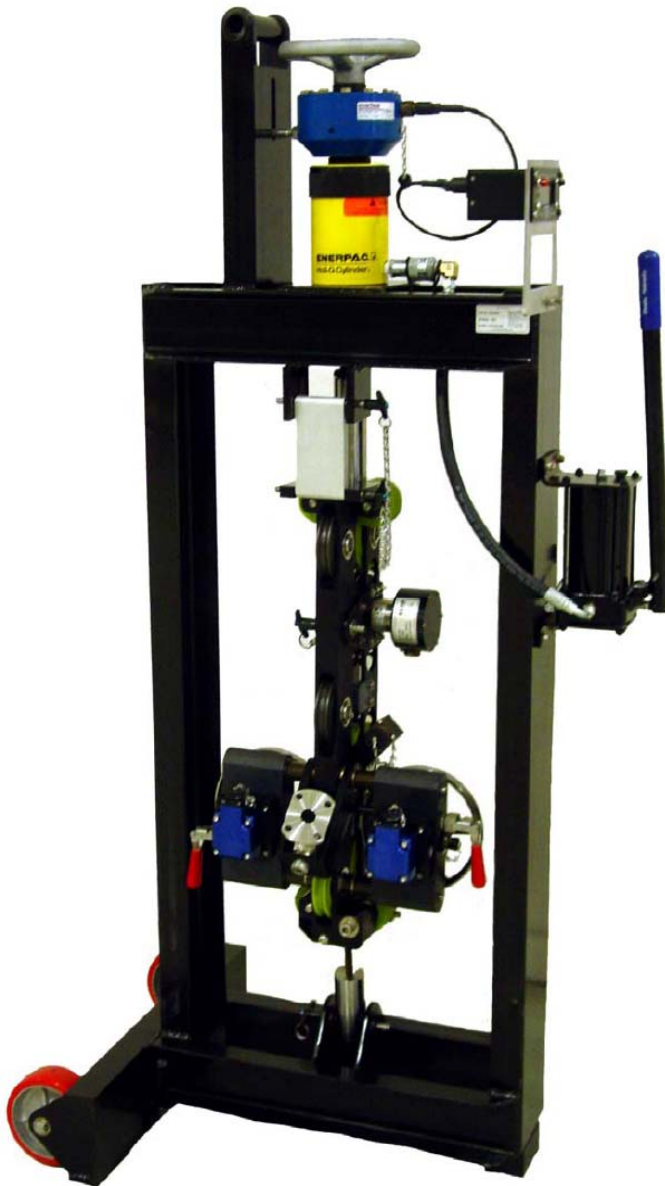

## CONFIDENTIAL

This document is confidential and contains information regarded as confidential and privileged.

The information in this manual may not be copied in whole or in part in any way or distributed to 3rd parties without the explicit permission of BenchMark Wireline Products Inc.

While all measures are taken to ensure accurate and complete coverage of the panel functions and specifications, no claim is made to the accuracy or integrity of the information provided in this manual.

All instances of query should be directed to the manufacturer, BenchMark Wireline Products Inc, 39220 FM 1093, P.O Box 850, Simonton, Tx 77476, Texas, USA, tel. +1.281.346.4300, url. [www.benchmarkwireline.com](http://www.benchmarkwireline.com).

## TABLE OF CONTENTS

- 1 INTRODUCTION
  - 1.1 Calibration Standards
  - 1.2 Verification Standards
- 2 LOAD PIN CALIBRATION
  - 2.1 LOAD PIN ACCURACY AND REPEATABILITY
- 3 FSU2A150 TENSION TEST STAND
  - 3.1 FSU2A155 Specifications
  - 3.2 FSU2A150 Specifications
  - 3.3 Test Stand Use Instructions
  - 3.4 Load Pin Calibration And Verification
    - 3.4.1 Load Pin Verification
    - 3.4.2 Load Pin Calibration
    - 3.4.3 AM3K and AM5K Loan Pin Zero Offset Adjustment (AMTK014 Amplifier PC Board)
    - 3.4.4 AM3KA015 and AM5KA069 Load Pins (AMTKA014B Amplifier PC Board)
    - 3.4.5 FSU2A155 Drawings
    - 3.4.6 FSU2A155 Parts List
- 4 ALS8A TENSION PANEL
  - 4.1 ALS8A Tension Panel Operating Instructions (e.g. ALS8A102)
  - 4.2 ALS8A Specifications
    - 4.2.1 ALS8A010-2 Cable Assembly (Load Cell to ALS8A100)
    - 4.2.2 ALS8A012-5 Cable Assembly (Load Pin to ALS8A101 Secondary Tension Display Panel)
    - 4.2.3 A AMS4A351-20 Cable Assembly (Load Pin to Logging System)
- 5 FURTHER TECHNICAL ASSISTANCE
  - 5.1 Equipment Return

APPENDIX 1 – LINE TENSION MEASURING OVERVIEW

APPENDIX 2 – TENSION DEVICES

LOAD PIN VERIFICATION TRACKING SHEET – Blank form to copy

## 1.0 INTRODUCTION

Tension instruments, as per all measurement devices, require calibration and verification in order to provide limited uncertainty in the validity of the provided measurements.

Calibration is the process of determining the relationship between an instrument response and a recognized standard of engineering unit value.

Verification is the process of assuring that the instrument response using the calibration provided complies with a given recognized engineering unit response within specified limits.

The calibration relationship can be a digital (on/off) signal, can be a linear equation, or can be a complex multi-parameter relationship. In any case, the relationship established is valid until there is reason for the calibration to be renewed.

The verification standard used can be either fixed or can vary in value, as long as the actual engineering unit response is a given, and there is an appropriately reasonable way of recognizing any excursion beyond the acceptable measurement error margin.

Validation and calibration are performed on the BenchMark Wireline FSU2A Tension Test Stand. Two stands are available, the larger 155B and the 150B. Both are described in this manual. This document will provide the basis for the calibration and verification of BenchMark Wireline tension measurement products.

### 1.1 CALIBRATION STANDARDS

Instrument calibration values are provided based on a standard against which the calibration response is defined. These standards are traceable to A NIST (National Institute of Standards and Technology).

The calibration standard is based on a calibrated load cell that is put in series with a measuring head that then has a load pin mounted for calibration. This is done using the BenchMark FSU2A150 Tension Test Stand (see Figure 20). The load pin is mounted in either a BenchMark defined calibration standard AMTKA tension device or an AM3K or AM5K measuring head. When using different size lines, adjustment to take into account differing geometric factors is then made using the panel set-up software to account for the effects of line size.

It is imperative that the AM5K, AMTK, or AM3K to be used as the calibration standard must be in good repair and within specification or the calibration will be in error. A specially configured AMTK can be purchased to be used as a calibration standard.

The FSU2A Tension Test Stand Master Calibration Load Cell is re-calibrated every two years based on NIST defined load values by an external calibration lab (refer to section 5 for calibration instructions).



The American Association for Laboratory Accreditation

SCOPE OF ACCREDITATION TO ISO 17025:2005  
& ANSI/NCSL Z540-1-1994

INTERFACE, INC.  
 7401 E. Butherus Drive  
 Scottsdale, AZ 85260  
 LaVar Clegg Phone: 480 948 5555 ext 106

CALIBRATION

Valid To: November 30, 2012

Certificate Number: 1991.01

In recognition of the successful completion of the A2LA evaluation process, accreditation is granted to this laboratory to perform the following calibrations<sup>1</sup>:

I. Electrical – DC & Low Frequency

Parameter/Equipment	Range	CMC <sup>2</sup> (±)	Comments
DC Voltage – Measure	(0 to 0.14) V (0.14 to 1.4) V (1.4 to 14) V (14 to 140) V	0.0026 % rdg + 0.2 μV 0.0024 % rdg + 2 μV 0.0022 % rdg + 20 μV 0.0022 % rdg + 200 μV	Solartron 7071
DC Voltage Ratio	(0 to 0.1)	0.0007 % rdg + 0.1 μV/V <sub>ref</sub>	Kelvin-Varley divider
Resistance – Measure	(0 to 1.4) kΩ (0.14 to 1.4) kΩ (1.4 to 14) kΩ (14 to 140) kΩ (140 to 1400) kΩ	0.0026 % rdg + 0.2 mΩ 0.0026 % rdg + 2 mΩ 0.0026 % rdg + 20 mΩ 0.0028 % rdg + 0.2 Ω 0.0036 % rdg + 2 Ω	Solartron 7071

(A2LA Cert. No. 1991.01) 09/21/2010

5301 Buckeystown Pike, Suite 350 | Frederick, Maryland 21704-8373 | Phone: 301 644 3248 | Fax: 301 662 2974 | www.A2LA.org

  
 Page 1 of 2

Calibration Lab Load Cell Accreditation p.1

II. Mechanical

Parameter/Equipment	Range	CMC <sup>2</sup> (±)	Comments
Force – Load Cells, Force Transducers	(200 to 240 000) lbf	0.035 % rdg	Load cells
	(100 to 1100) lbf	0.050 % rdg	
	(240 000 to 1 000 000) lbf	0.041 % rdg	
	(1 to 500) lbf	0.040 % rdg	Free weights
	(25 to 1100) lbf	0.030 % rdg	Actuated weights
	(10 to 550) lbf	0.021 % rdg	Actuated weights (stainless steel)
	(25 to 2000) gf	0.030 % rdg	Free weights
Torque – Torque Transducers	(8.8 to 177) in-lb	0.052 % of rdg	Torque arm and weights
	(40 to 2200) in-lb	0.040 % of rdg	
	(1700 to 10 000) in-lb	0.11 % of rdg	Transducer comparison
	(4400 to 50 000) in-lb	0.070 % of rdg	
	(2000 to 100 000) in-lb	0.14 % of rdg	

<sup>1</sup> This laboratory offers commercial calibration service.

<sup>2</sup> Calibration and Measurement Capability (CMC) is the smallest uncertainty of measurement that a laboratory can achieve within its scope of accreditation when performing more or less routine calibrations of nearly ideal measurement standards or nearly ideal measuring equipment. Calibration and Measurement Capabilities represent expanded uncertainties expressed at approximately the 95 % level of confidence, usually using a coverage factor of  $k = 2$ . The actual measurement uncertainty of a specific calibration performed by the laboratory may be greater than the CMC due to the behavior of the customer's device and to influences from the circumstances of the specific calibration.



The American Association for Laboratory Accreditation

World Class Accreditation

## Accredited Laboratory

A2LA has accredited

**INTERFACE, INC.**

Scottsdale, AZ

for technical competence in the field of

**Calibration**

This laboratory is accredited in accordance with the recognized International Standard ISO/IEC 17025:2005 *General Requirements for the Competence of Testing and Calibration Laboratories*. This laboratory also meets the requirements of ANSI/NCSL Z540-1-1994 and any additional program requirements in the field of calibration. This accreditation demonstrates technical competence for a defined scope and the operation of a laboratory quality management system (refer to joint ISO-ILAC-IAF Communiqué dated 8 January 2009).

Presented this 21<sup>st</sup> day of September 2010.



*Pete Almy*  
\_\_\_\_\_  
President & CEO

For the Accreditation Council  
Certificate Number 1991.01  
Valid to November 30, 2012

*For the calibrations to which this accreditation applies, please refer to the laboratory's Calibration Scope of Accreditation.*

## Calibration Lab Certification

### 1.2 VERIFICATION STANDARDS

BenchMark provides the FSU2A Tension Test Stand for clients for use as a verification jig for their measuring heads. Clients use this to verify, as well as calibrate, their measuring head tension readings.

A variance of +/- 3% (or 150 lbs, whichever is greater) is recommended as being acceptable for field operations.

On-site and before- and after-job verification consists of checking the panel response to known line loads represented by the tool string weight. These results are field checked, but not noted or otherwise formalized. There are no specific values or tolerances recommended, as field conditions can vary considerably.

## 2.0 LOAD PIN CALIBRATION

Calibration of the Load Pin is done using a Master Calibration AMTKA tension head, or a Master AM5K or AM3K for Load Pins that are specific to those devices.

When using an AMTK and AM5K measuring head, a 17/32" ("Slammer") cable is used. When using an AM3K measuring head, a 5/16" cable is used. Variances in the size of the actual cable used are taken into account in the readout panel software set-up.

The calibration procedure consists of subjecting the Load Pin to zero load, and then either 5,000 or 10,000 lbs, depending on the type of pin. The output of the Load Pin is then adjusted to create the equivalent value of the Master Calibration load cell. When available, the calibration shunt output is then adjusted to provide a signal equivalent to the 5,000 or 10,000 lbs signal.

When performing a Master Calibration, (depending on the type of pin) three adjustments are made to the electronics using a voltmeter while observing the load cell registered load:

1. The zero offset is set to measure 0 V at zero load.
2. The full scale output (gain) is adjusted to read "full scale" (depending on the type of pin) at 10,000 lbs, or whatever the full scale calibration value used is. This is, dependant on the load pin being used,  $\frac{3}{4}$  V or  $1 \frac{1}{2}$  V for 5,000 lbs load, or in the case of low voltage load pins, 25 mV for 10,000 lbs (4,536 kgs).

In the case of the differential load pin, the Load Pin shunt output is set to match 3,250 lbs.

3. The shunt resistance is then matched and adjusted to give an equivalent "full scale" output signal to match the calibrated signal output. (Note that the gain and shunt resistance settings can be mutually interfering, so several reiterations may be required to achieve the required responses.)

The calibrated Load Pin is then validated for use in any suitable device. Accurate measurements require entering the correct measuring head configuration and correct cable size into the software. This software then introduces the appropriate factors to scale the output accordingly.

There is no calibration for fixed output pins where there are no adjustments to be made.

It is recommended that the Load Pin is field-calibrated using this procedure every 6-months, or when the load values being given are questionable or out of tolerance, or when the pin is returned for service or repair.



Master Verification of the Load Pin can be performed using any standard suitable measure head.

A series of check points are then made to verify linearity of the response.

## **2.1 LOAD PIN ACCURACY AND REPEATABILITY**

Calibration accuracy of the test load pin should be the factory calibration is **FS (full scale) +/- 3%**.

Note that this figure applies **ONLY** to the Load Pin, and not the load pin when mounted in the used measuring head with the panel set-up accordingly.

The Load Pin Primary Verification includes a double check on values. These should be within the 3% FS specification.

This verification is made in steps when increasing, not decreasing test stand pressure. Taking measurements in decreasing steps can produce incorrect values due to the pressure bleeding in the hydraulic system.

There is no hysteresis measurement made or specification.

## 3.0 FSU2A155 TENSION TEST STAND



**FSU2A155 Test Stand**

## 3.0 FSU2A150 TENSION TEST STAND

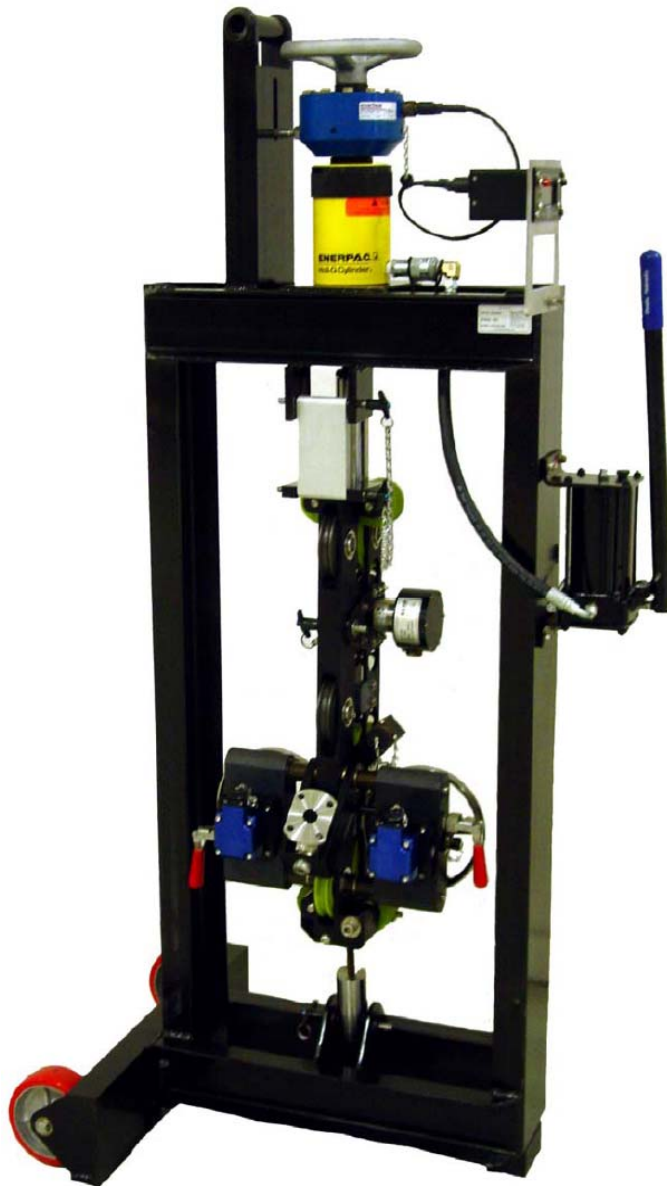

**FSU2A150 Test Stand**

## **FSU2A155 & 150 TENSION TEST STANDS**

The FSU2A Tension Test Stand is designed to calibrate and verify the tension reading of a BenchMark AM3K or AM5K measuring head.

There are two sizes of stand. The “short” stand (FSU2A150), and the “long” stand (FSU2A155).

A short piece of actual logging cable is installed into the stand. Slip grips (or rope sockets in the “short” stand) are installed on each end of the cable to secure it to the blocks at the bottom and top of the stand. Tension is applied to the wireline to emulate the tension seen during operations. The tension is measured using a Master Calibrated load cell.

The Master Calibrated Load Cell is recalibrated to NIST standards every two years.

## LOAD CELL CALIBRATION CERTIFICATION

CONDITION: FINAL  
 MODEL: 1220ACK-25K SERIAL: 333910 BRIDGE: A CAPACITY: 25 K1bf  
 PROCEDURE: C-1257 Mounting Per Interface Installation Instruction 15-5

INPUT RESISTANCE: 351.2 OHM OUTPUT RESISTANCE: 351.1 OHM  
 ZERO BALANCE : 0.352 %RO

### TEST CONDITIONS

TEMPERATURE: 73 °F HUMIDITY: 33 % EXCITATION: 10 VDC

### TRACEABILITY

FORCE STANDARD : STD-13 NIST #: 822/275727-08 DUE: 15-NOV-11  
 STANDARD INDICATOR: BRD1 NIST #: 564714  
 TEST INDICATOR : BRD4 NIST #: 564714

### SHUNT CALIBRATION

	Shunt (± 0.01%)	Output	Straight Line Conversion	Connections*
Tension	30 Kohm	2.90532 mV/V	17.154 K1bf	-Out to -Exc
Compression	30 Kohm	-2.90433 mV/V	17.131 K1bf	-Out to +Exc

\*For models wired with +Sense, -Sense, or -Scale leads, resistor connections are actually to these leads in place of +Exc, -Exc, or -Out respectively.

### PERFORMANCE

	RATED OUTPUT	SEB OUTPUT	NONLINEARITY	HYSTERESIS	SEB
TENSION	4.23491 mV/V	4.23408 mV/V	-.019 %FS	-.009 %FS	± .020 %FS
COMPRESSION	-4.23912 mV/V	-4.23831 mV/V	-.027 %FS	.028 %FS	± .019 %FS

STATIC ERROR BAND (SEB) - The band of maximum deviations of the ascending and descending calibration points from a best fit straight line through zero OUTPUT. It includes the effects of NONLINEARITY, HYSTERESIS, and nonreturn to MINIMUM LOAD.

TEST LOAD APPLIED ( K1bf)	RECORDED READINGS (mV/V)	
	Tension	Compression
0	.00000	.00000
5	.84636	-.84707
10	1.69318	-1.69451
15	2.54064	-2.54259
20	3.38784	-3.39079
25	4.23491	-4.23912
10	1.69280	-1.69571
0	-.00028	.00016

Interface, Inc. certifies that all calibration measurements are traceable to NIST. Estimated uncertainty of measurements is 0.040%. Results relate to 333910 only. Do not reproduce this report except in full or with Interface written approval.

TECHNICIAN :  Pedro Beltran DATE :24-SEP-09

INTERFACE INC.  
 7401 EAST BUTHERUS DRIVE · SCOTTSDALE, ARIZONA 85260, U.S.A.  
 TELEPHONE (480)948-5555 · FAX (480)948-1924

**Figure 1 – FSU2A Master Load Cell Calibration**

## **FSU2A155 & 150 TENSION TEST STANDS continued**

The measuring head is then installed over the test cable and the cable is tightened using a hydraulic hand pump to provide the required calibration and verification tensions.

The reading from the Master Load Cell and the measuring head in the stand are then recorded and compared.

The maximum load is hydraulically limited to 13,500 lbs.

An actual calibration and verification load of up to 12,500 lbs can be applied to the measure head.

Equipment requiring calibration loads in excess of 12,500 lbs should not be calibrated using the FSU2A stand.

The load applied to the cable is measured by the round load cell on the top of the stand, and displayed on the ALS8A101 Master Load Cell tension display panel mounted on the front of the stand. The ALS8A101 panel used then gives a direct reading of the tension load that the measuring head is subject to.

The measuring head is connected to the second ALS8A panel mounted under the Master Load Cell tension device. The type of panel used depends on the type of load pin being calibrated and/or verified.

The tension values displayed on the secondary display should closely match the actual applied tension. Any out of tolerance measurements will reflect issues that need to be corrected in the Load Pin (such as internal electronic settings) or in the measuring head (such as worn bearings, damaged or out of alignment shafts, worn wheels, etc.).

**FSU2A155 & 150 TENSION TEST STANDS continued**

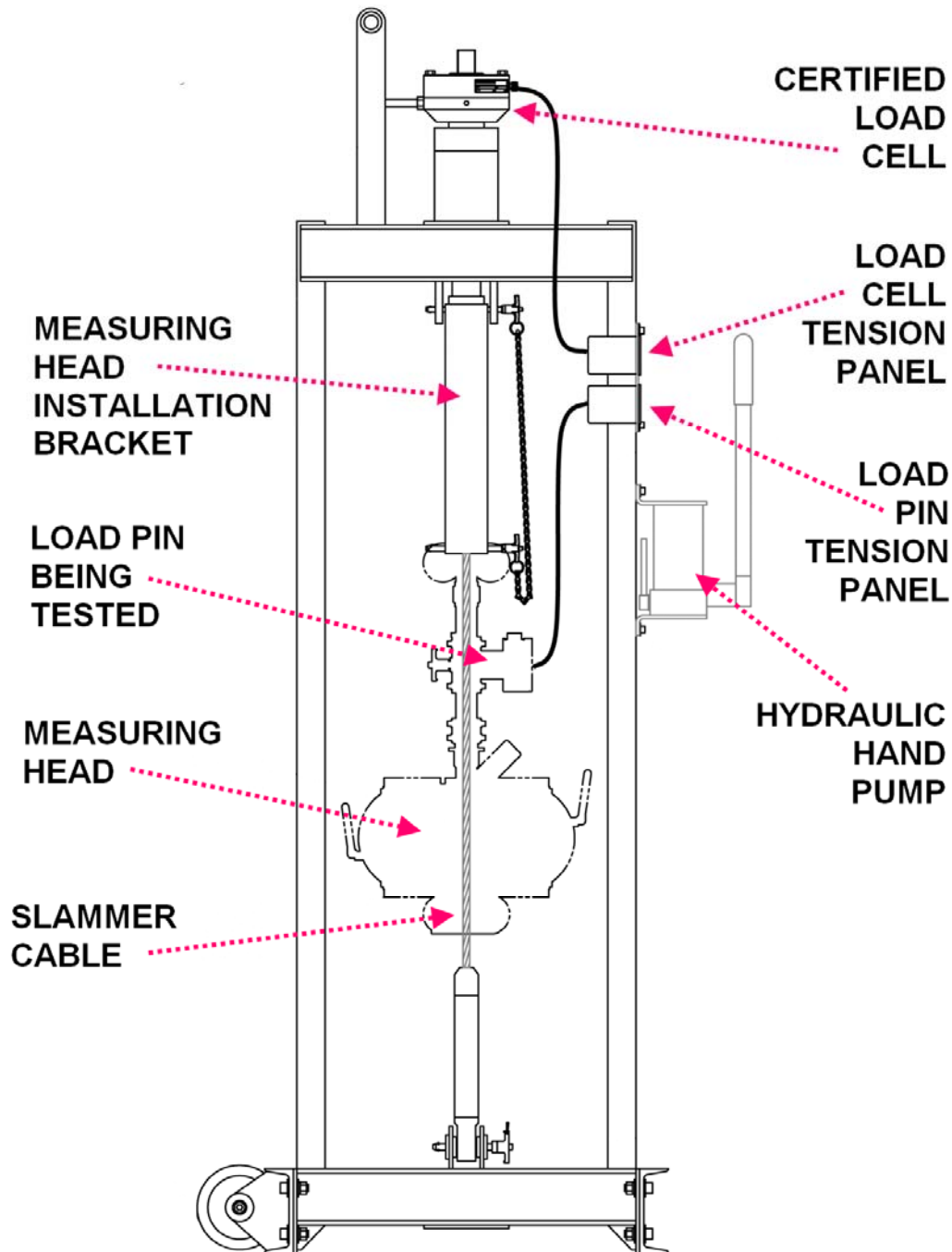

**FSU2A TENSION TEST STAND MAJOR COMPONENTS**

### 3.1 FSU2A155 SPECIFICATIONS

Weight: 350 lbs 159 kgs  
Height: 88.4" 2.25 m  
Width: 39.1" 0.99 m  
Depth: 28.5" 0.72 m  
Relief Valve Set: ~13,000 lbs ~5,900 kgs  
Hydraulic Oil Enerpak HF-101, viscosity 32, 1-pint  
BenchMark P/N FSU2P101

### 3.2 FSU2A150 SPECIFICATIONS

"Short" stand

Weight: 295 lbs 134 kgs  
Height: 68.4" 1.74 m  
Width: 39.1" 0.99 m  
Depth: 28.5" 0.72 m  
Relief Valve Set: ~13,000 lbs ~5,900 kgs  
Hydraulic Oil Enerpak HF-101, viscosity 32, 1-pint  
BenchMark P/N FSU2P101



### 3.3 TEST STAND USE INSTRUCTIONS

#### 1. Set the required cable into the test stand.

For AM5K measure heads, use .474 (Slammer) cable.

For AM3K measure heads, use 5/16" wireline.

Any line size can be used, given that the panel is set to that line size during the calibration procedure. The above recommended cable sizes are for guidance only, and the most commonly used line size at the location may also be used.

Using the upper adjustment wheel, take up the slack in the cable so that the test cable is just slack.

Note: if a new cable is required, make up the test cable (for 150, cable length is 38.5" and use cone sockets and associated cone bracket; for 155, cable length is 57.5" and use slip grips – 155 end to end length, including rope sockets, is 60.5"). Pull up to 12,500 lbs for .474 Slammer or 6,000 lbs for 5/16", and then release. Repeat this step at least six times to pull the stretch out of the cable.

Note: After the cable has been used many times for testing, a bend in the cable may form where it bends around the tension wheel. If so, subject the cable to a 12,000 lbs (for .474 Slammer) or 6,000 lbs (for 5/16" cable) load and leave it for an hour to straighten itself out.

If the cable is kinked or out-of round, the cable can be top-to-bottom reversed.

If the cable is worn or stretched in any way, replace it. The cable should be replaced periodically.

One method to determine if the cable needs to be replaced is the check the roundness of the cable at the position where it is in contact with the tension wheel. If the cable is worn more than .008" from the original size than the cable will need to be replaced or swapped end for end.

#### 2. Mount the measure head by hanging it off the spacer support bar and by connecting the top frame of the measuring head to the mounting bracket. Use the locking pin to secure the head to the bracket. Install the test cable into the measuring head being sure that the cable is properly positioned between the various spacer and guide wheels.

Make sure that the measuring head and cable are now hanging freely and easily in the test stand.

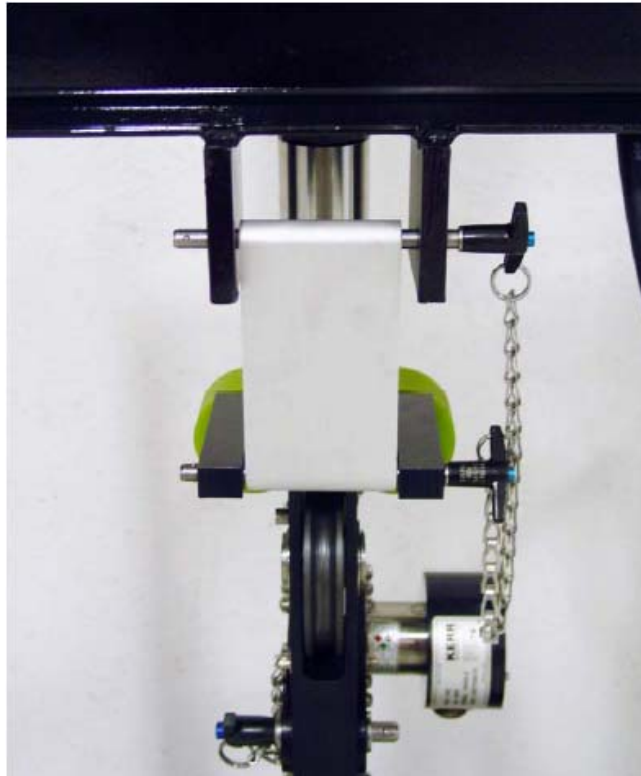

### **FSU2A150 Measuring head Installation Bracket**

**3.** Connect the appropriate ALS8A tension display panel suitable for the Load Pin being used using the connector cable needed for the connector.

See the individual ALS8A Operating Manual for instructions per panel.

**4.** Set the Master Load Cell ALS8A tension display panel internal set up to match the load cell.

The measuring head with Load Pin are now ready to be either calibrated or verified using the FSU2A.

### **3.4 LOAD PIN VERIFICATION AND CALIBRATION**

Verification will be initially explained, where the Load Pin calibration is checked against the Load Cell defined values.

Calibration, when possible and when necessary, involves internal adjustment of the zero and gain settings of the Load Pin electronics, and the setting of the shunt to match a defined calibration value.

\*NOTE – you can watch videos that show the entire process of Verification and Calibration on the [BenchMarkWireline.com](http://BenchMarkWireline.com) website.

#### **3.4.1 LOAD PIN VERIFICATION**

The Load Pin verification does not change the readings of the Load Pin, but checks that the readings obtained conform to the accuracy specifications.

This test assumes that the proper measuring head and matching slammer cable are installed.

Make sure that you have the correct model of tension display to match the type of load pin you are working with.

- 1.** Make sure that the cable assembly from the load cell is connected to the top tension panel. Then connect the lower tension panel to the load pin being tested.
- 2.** Manually check the measuring head to verify that it's in good working order and to make sure that it is properly installed on the cable.
- 3.** The cable needs to be at Zero tension there should be some play in it.
- 4.** Zero out the readings on both of the tension panels. This is done by holding up the Enable button and while holding, press the Zero button. Both the load cell and the load pin need to be synchronized to zero to perform validation.

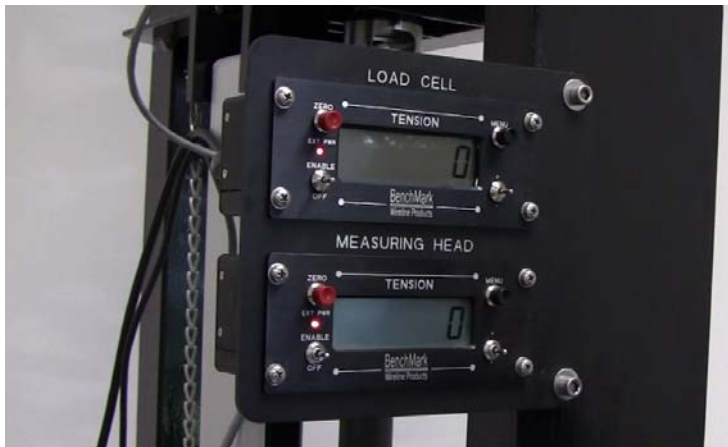

5. Any increase in tension in the load cell should also be seen correspondingly in the load pin. The load cell is periodically certified for accuracy so the load pin is being compared with it during this validation.

6. We recommend that you record the result of this test. A copy of this sheet is available from BenchMark Wireline. Begin with the asset number of the measuring head and the test stand. To maintain traceability, the load cell is linked to the test stand through the measuring head to the load pin.

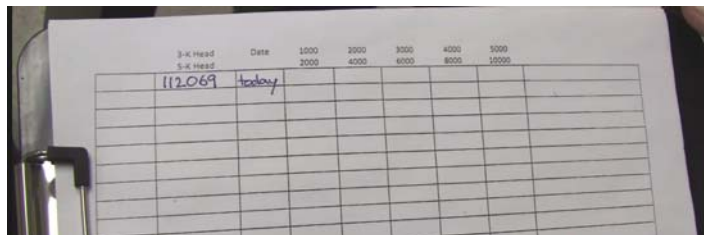

7. The test tension measurements that are taken depend on the measuring head and are listed on the tracking sheet. Measurements will be taken twice in the increments shown on the sheet. A third test will be performed using only 0 and then the maximum tension allowed by the machine.

Typical values used are:

Sequence #	1	2	3	4	5
AM3K	1,000 lbs	2,000 lbs	3,000 lbs	4,000 lbs	5,000 lbs
AMTK/AM5K	2,000 lbs	4,000 lbs	6,000 lbs	8,000 lbs	10,000 lbs

The test series is designed to measure both accuracy and repeatability.

**8.** Begin to pump the hydraulic system handle. Pressurize the system and increase tension on the load cell, the top tension panel to 2000 pounds.

**9.** The indicator on the panel connected to the load pin should increase at approximately the same rate. Gradually increase the pressure up to and just beyond the 2000 pound number. At that point, quickly notice the reading on the lower panel and record that reading on the sheet. Because of gradual pressure bleed, the numbers will decrease slightly unless the tension pressure hold valve is used.

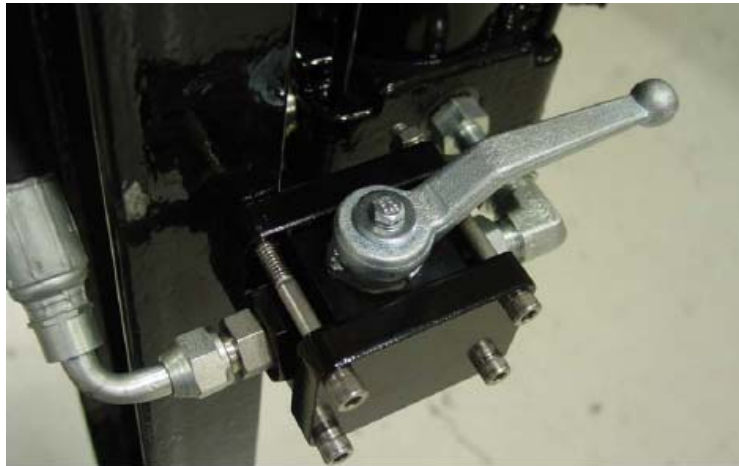

**10.** Repeat the process for 4000 pounds and write down the number. In this example the pressure number stopped at 4001 on the load cell and it was allowed to bleed down to 4000. At that point the corresponding load pin number was 4168. The number 4168 is recorded on the sheet. The readings are more accurate if you can avoid going over the target pressure number.

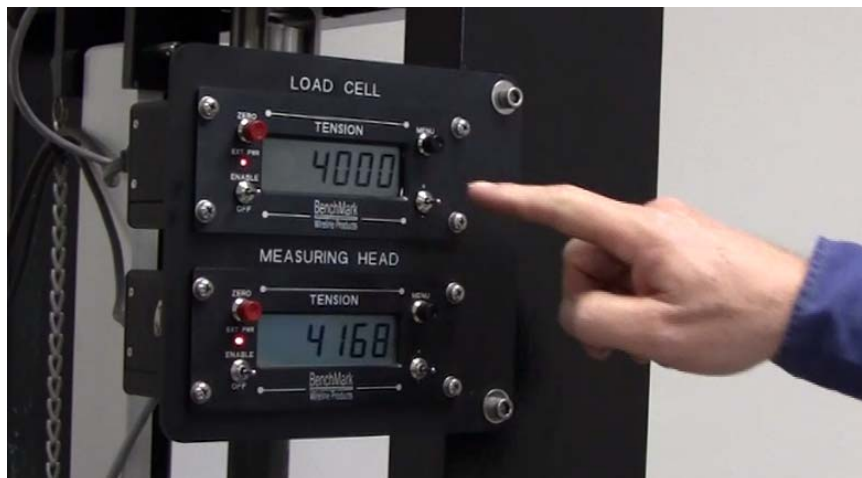

**11.** Repeat the process for 6000, 8000 and 10000.

Looking at the recorded numbers in the example shows that the variance is quite consistent across the range and that the difference at the maximum pressure is 234 pounds at 10000 which is 2.3%.

12. Use the pressure release handle and allow the pressure to return to zero.

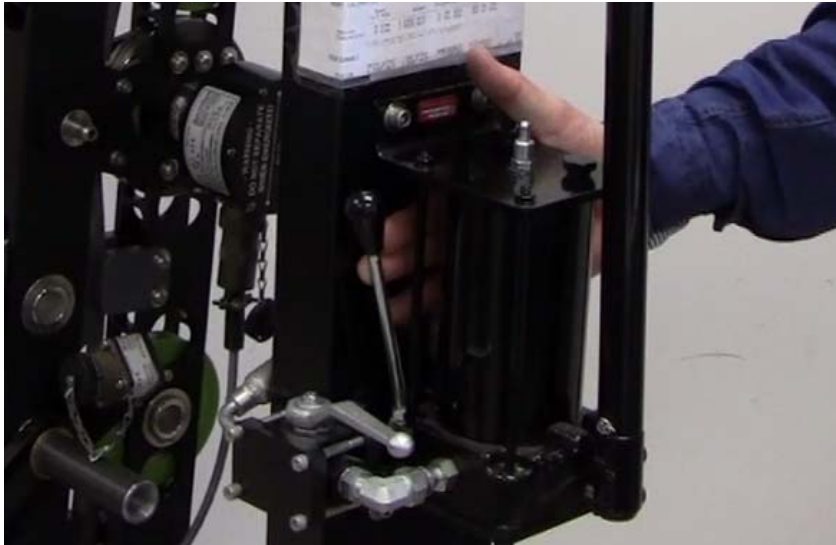

13. Now reposition the pressure release handle and verify that the cable is slack. Pump up the system slightly to get the reading on the top panel to about zero.

14. Zero out both panels and repeat the same multi step tension testing procedure and record the readings. Do the same for the third cycle which tests only zero and 10000.

15. In this example the greatest variance was 234 which was a difference of 2.3%. The acceptable range is +/- 3%. Furthermore, with each round of tests the variance between the load cell and the load pin decreased meaning that the accuracy of the load pin increased with repeated testing. This would indicate that this load pin operates within acceptable variance and is working properly.

3-K Head	Date	1000	2000	3000	4000	5000	
5-K Head		2000	4000	6000	8000	10000	
112069	today	2136	4168	6182	8196	10234	+234
		2090	4083	6045	8072	10130	+130
						10073	+73

**16.** If when pressurizing the hydraulics you significantly overshoot a tension mark, do not allow the meter to bleed down and use that reading. Because of the lag in the hydraulic system it will most likely give an incorrect reading.

Rather, go below the tension mark and pressurize up to the mark again and then take the reading.

**17.** Field verification – pick up a tool string and note the weight prior to the job. When completed and while still in the derrick, note the weight again. If the before and after weights are within 3% of each other, the load pin is acceptable.

It is recommended that these tests be performed monthly to assure that you are getting accurate well site readings.

### **3.4.2 LOAD PIN CALIBRATION**

During the Load Pin calibration, the output of the Load Pin is compared to a known standard and depending on the type of pin, the electronics are adjusted to provide a signal output that will emulate the standard.

The setup is as described above for Primary Verification.

An AMTKA555 special inline tension measuring device or a new AM3K/AM5K calibration head should be used. The AMTKA555 should be used only for the verification / calibration of load pins. It should be kept in new condition and the wheels on it should not have any wear. This device does not come with a load pin installed. The load pin to be calibrated is inserted into the device.

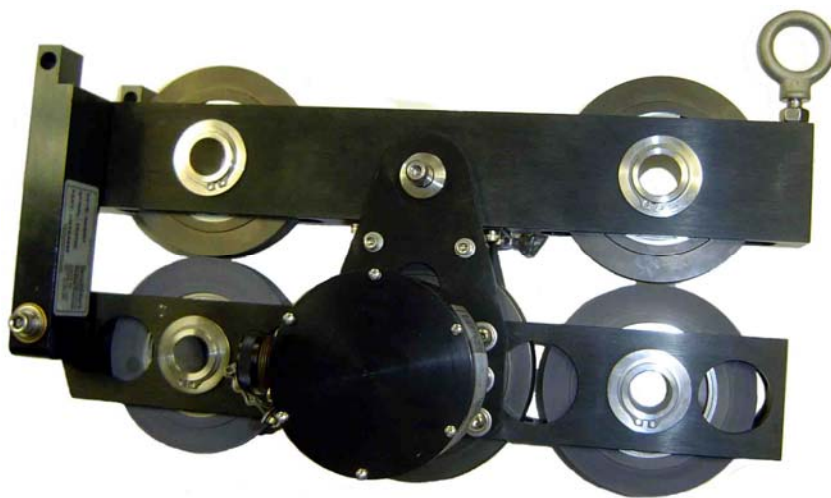



Different load pins may have different individual procedures, and the procedure described below is generic for an amplified Load Pin with Zero, Gain and Shunt controls. See the documentation per Load Pin for specifics.

1. Open the Load Pin access plate, and locate the Zero, Gain and Shunt potentiometers. If necessary, remove previously applied mastic or RTV.



Connect the Load Pin to a suitable ASL8A panel, or have a stable appropriate DC power supply available.

2. Relax the cable to zero tension (hand flexible).

Identify the output signal line, and attach a multi-meter (mV).

Identify the excitation voltage lines, and attach a multi-meter (V).

Note: BenchMark use a Fluke 189 Digital/Analogue Multimeter with voltage measurement specifications of: Voltage DC Accuracy\*  $\pm (0.025\%+5)$ , Max. Resolution 1  $\mu\text{V}$ , Maximum 1000 V.

3. Adjust the Zero potentiometer to read 0 mV/V output from the circuit.





4. Increase the load to 5k lbs or 10k lbs as indicated by the Master Load Cell and adjust the Gain to read the mV value for that type of Load Pin (See Appendix 1 for mV/V specifications.)



5. Bear in mind that the Zero and Gain potentiometers both affect the mV reading, so several reiterations of these adjustments may be needed to achieve balance between the two settings.

**SHUNT CAL potentiometer**

**GAIN potentiometer**

**ZERO potentiometer**

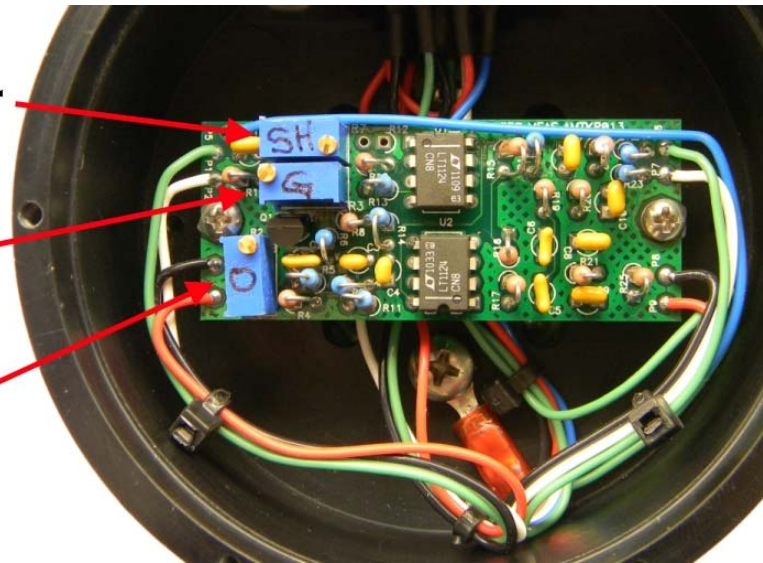

### Typical Amplified Load Pin Electronics

6. Read the mV output of the Shunt, and adjust the Shunt potentiometer to read exactly the same mV value as when at the calibration value of the designated Shunt value.
7. Check the mV output values, and adjust the potentiometers accordingly. There may be slight adjustments needed to achieve balance between the three potentiometer settings.
8. The mV output of the Load Pin is now set to read the exact equivalent of the values required when relaxed and when at the calibration load (5k or 10k lbs, depending on the Load Pin and the measure head).
9. With the cable relaxed, attach the ALS8A panel, and test the Load Pin response. Zero the tension by pressing the ZERO button on the ALS8A tension display panel, and tension up the cable to read the 5k or 10k calibration value. The panel should read the same (with 3%) as the Master Load Cell ASL8A.
10. Relax the tension. Put RTV (BenchMark uses Dow Corning 3145 or RTV 738 sealant) on the potentiometer screw adjustors, and close up the Load Pin housing lid.
11. Go through the Primary Verification routine to check values, and to see that the linearity of the response is as per specifications.

### 3.4.3 AM3K AND AM5K LOAN PIN ZERO OFFSET ADJUSTMENT (AMTK014 Amplifier PC Board)

Applicable to AMTKA010, AMTKA022 LOAD PINS

Adjust R10 to change the offset. R16 sets the gain.

If you can bring the offset close to 0 by making only a small change then it should not affect the other settings. Changing the offset by a significant amount will affect the other settings. The load pin will then need to be returned to BenchMark to be re-calibrated.

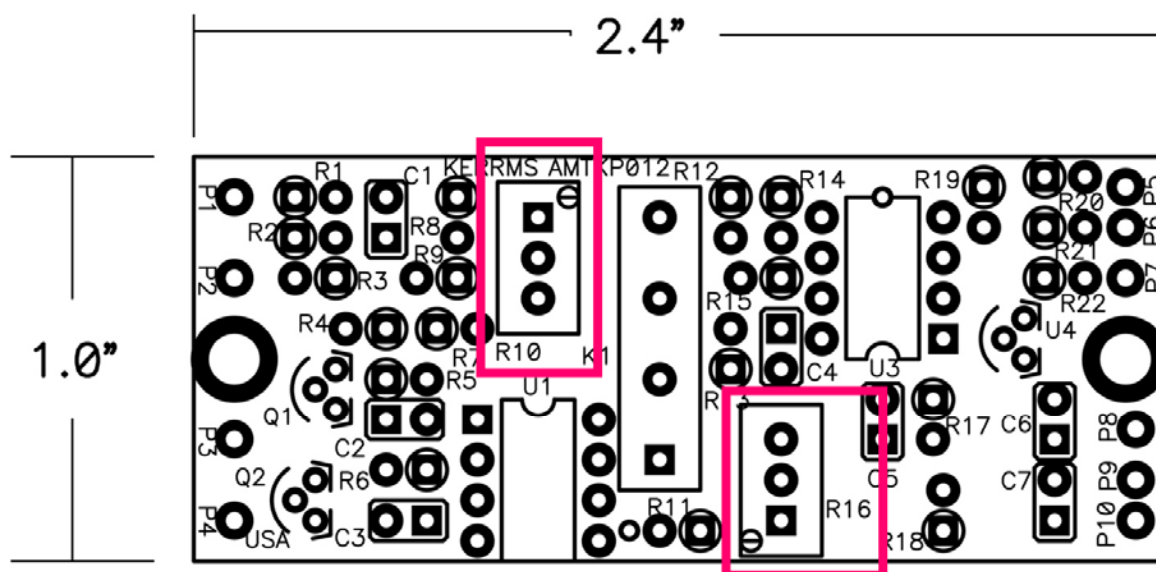

PCB ASSY – AMPLIFIER – TENSION – DIFFERENTIAL Ø – 1.5  
 17 AUG 01  
 TKA014.PCB

### AMTK014 Amplifier PC Board Physical Layout

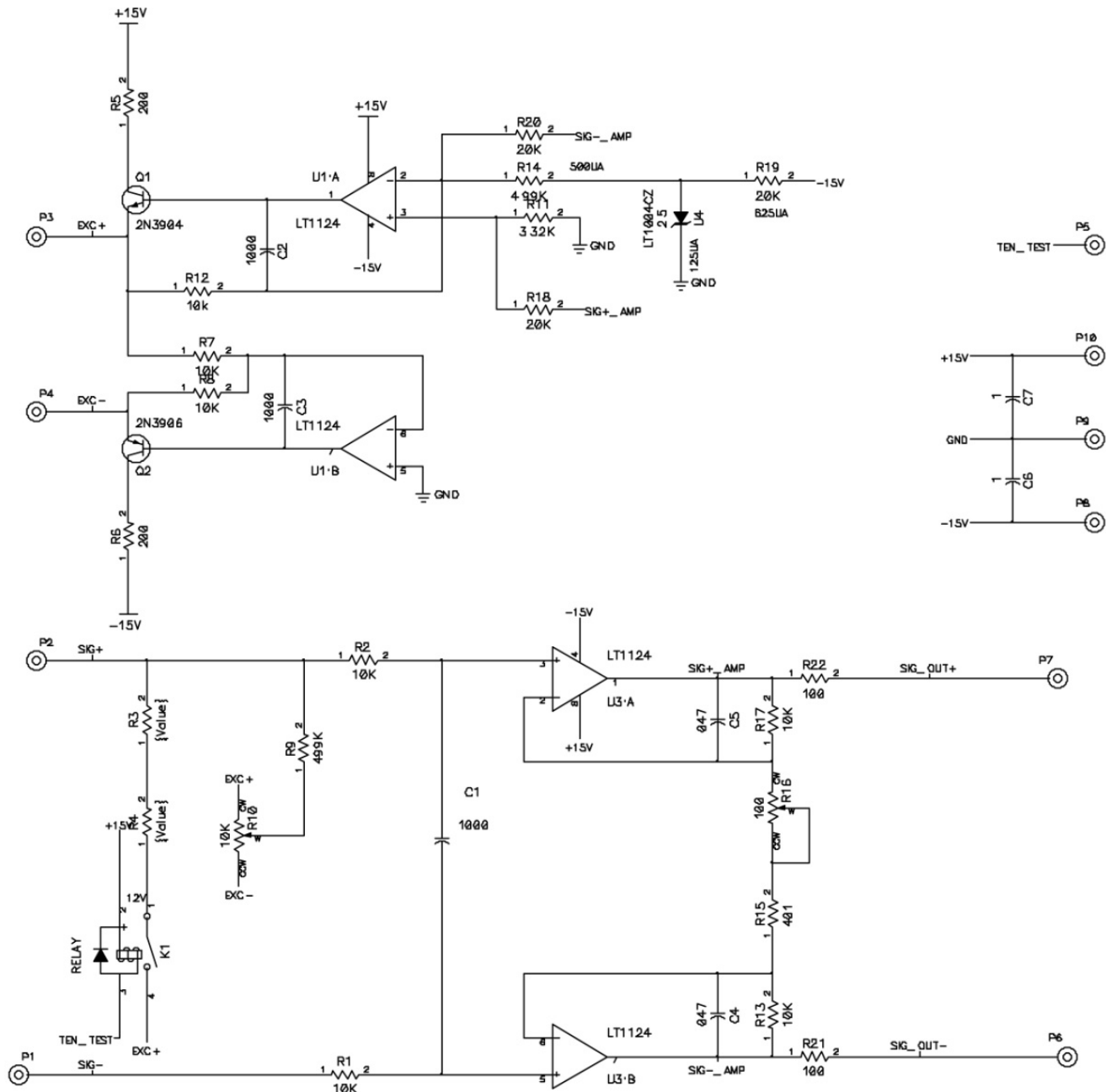

**AMTK014 Amplifier Electronic Circuit**



### AMTK014 Amplifier PC Board Connections

#### 3.4.4 AM3KA015 AND AM5KA069 LOAD PINS (AMTKA014B AMPLIFIER PC BOARD)

Adjust R1 to change the offset. R13 sets the gain and R18 sets the shunt cal value.

If you can bring the offset close to 0 by making only a small change then it should not affect the other settings. Changing the offset by a significant amount will affect the other settings. The load pin will then need to be returned to BenchMark to be re-calibrated.

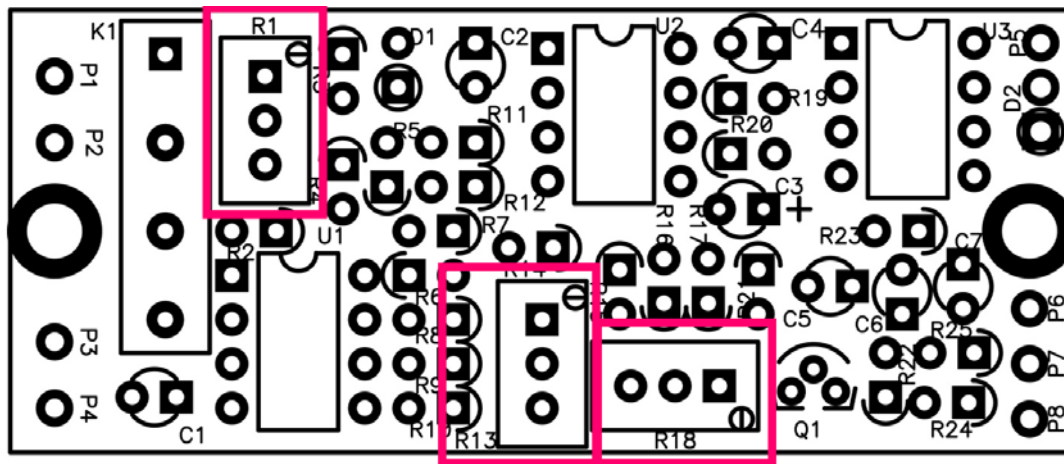

### AMTK014B Amplifier PC Board Physical Layout

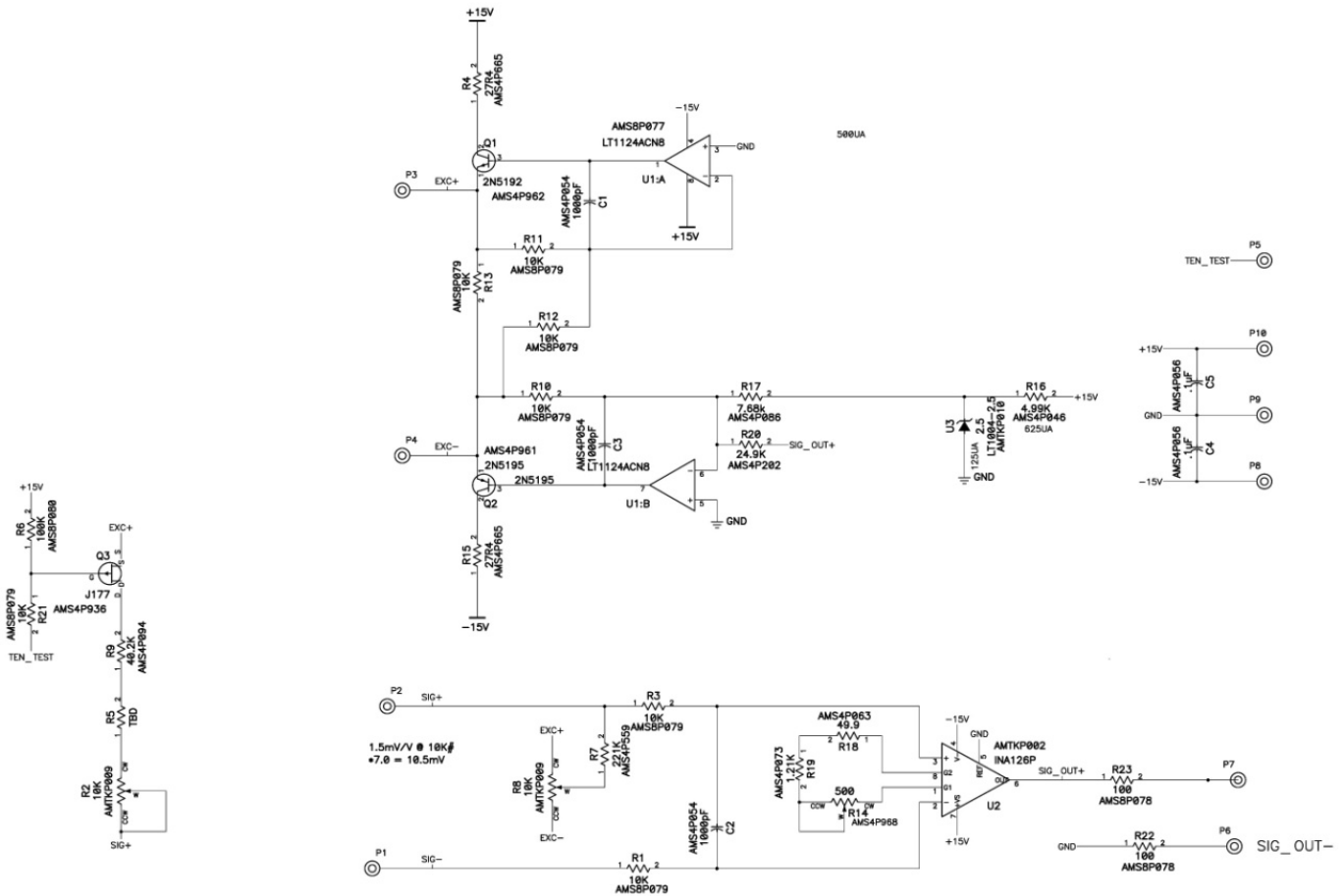

**AMTK014B Amplifier Electronic Circuit**

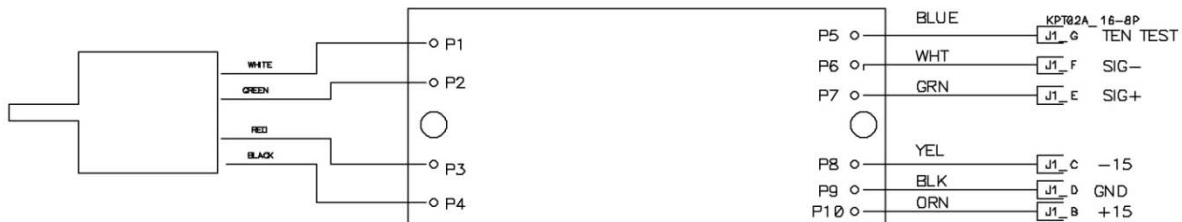

**AMTK014B Amplifier PC Board Connections**

### 3.4.5 FSU2A150 & 155 TENSION TEST STAND DIMENSIONAL DRAWINGS

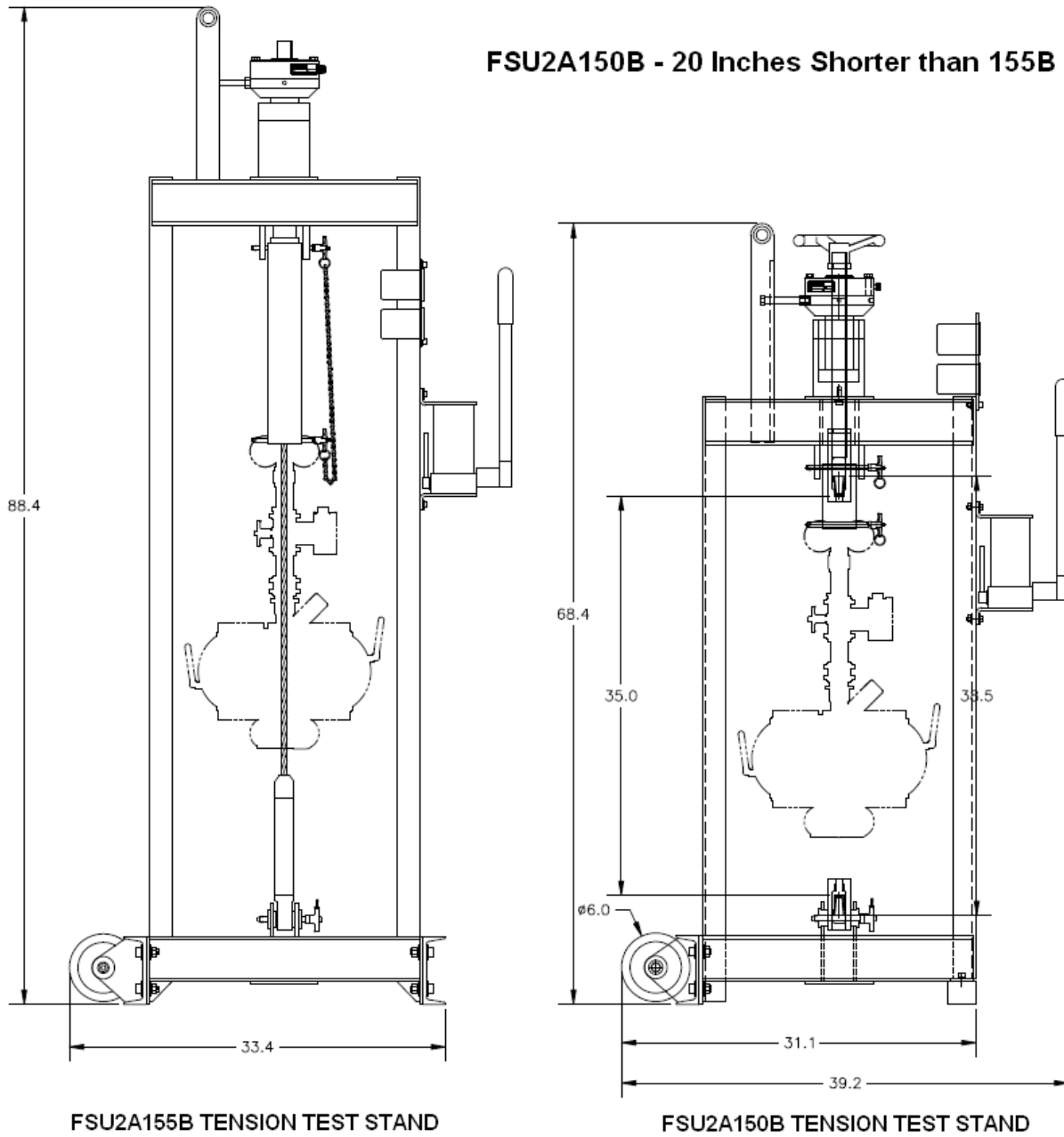

### 3.4.5 FSU2A155 TENSION TEST STAND DRAWINGS continued

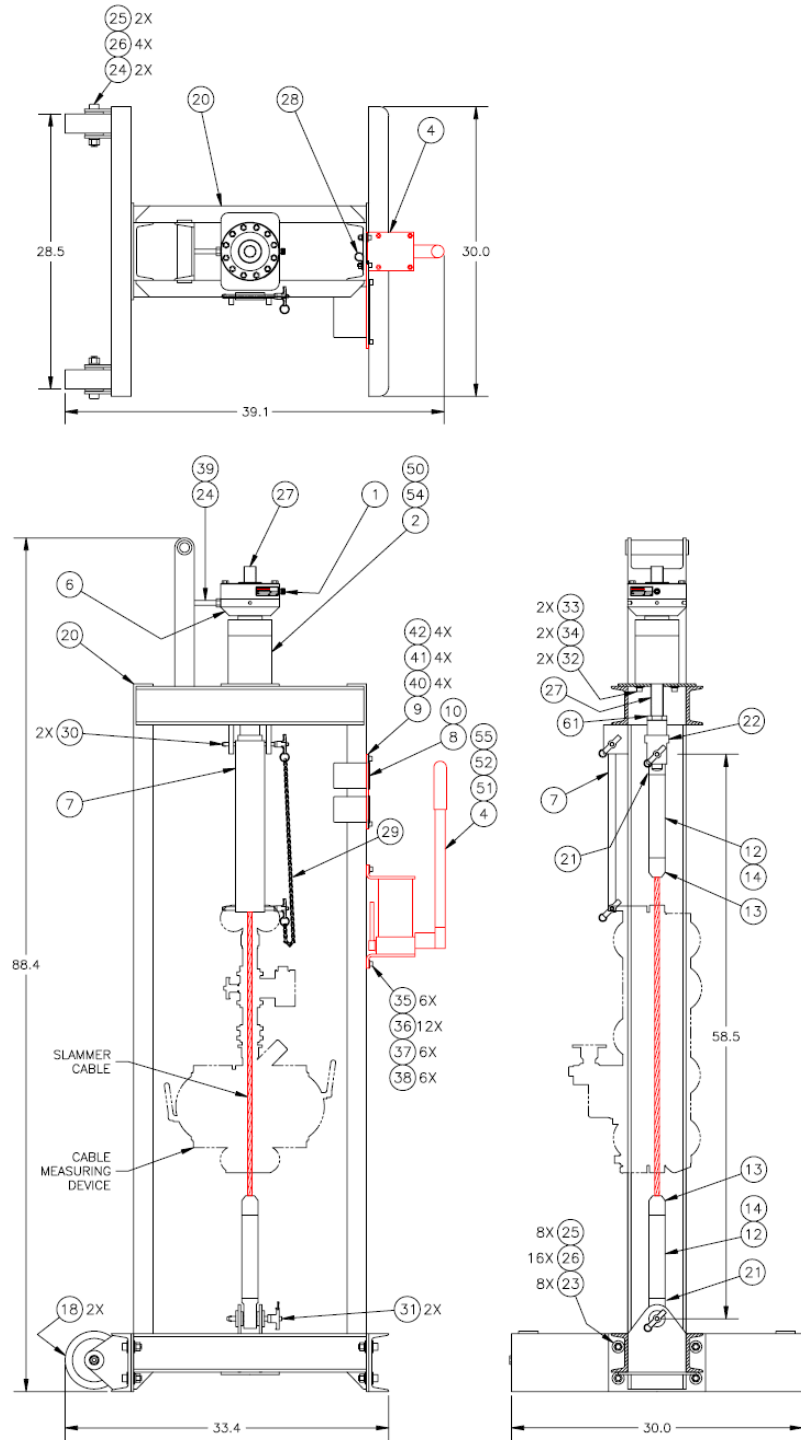

**FSUA155 General Arrangement Diagram**



### 3.4.6 FSU2A155 TENSION TEST STAND BILL OF MATERIALS

ITEM	P/N	DESCRIPTION	QTY.	REF
1	FSU2P125	LOAD CELL 25,000 LB UNIV FLAT 4.0-mV/V 350 OHM STL 6 PIN	1	
2	FSU2P130	CYLINDER 30T 2.50" STROKE HOLLOW ROD	1	
4	FSU2P122	PUMP HYD HAND 6KPSI 50CUIN ADJ RELIEF PRESET TO 2100PSI	1	
5	FSU2M145	WHEEL HAND 8 IN DISHED 1-1/4-12 THD	1	
6	FSU2M126	BASE MOD LOAD CELL 25K	1	
7	FSU2M158	KNUCKLE UPRIGHT SLIP TENS TST	1	
8	ALS8A100	PANEL AMS TN BKUP DSP BATT mV/V FOR PANCAKE LOAD CELL	1	
9	FSU2M156	PLATE DUAL TENSION DISPLAY SLIP-TYPE TENSILE TESTER	1	
10	ALS8A010-3	CABLE ASSY BACKUP TENSION TO LOAD PIN MEAS HEAD TEST FIXTUR	1	
12	FSU2P160	BODY ROPE SOCKET 1-11/16 OD	0	REF
13	FSU2P161	CONE NOSE ROPE SOCKET 17/32	0	
13	FSU2P166	CONE NOSE ROPE SOCKET 1/4	0	OPTION
13	FSU2P167	CONE NOSE ROPE SOCKET 5/16	0	OPTION
13	FSU2P168	CONE NOSE ROPE SOCKET 3/8	0	OPTION
13	FSU2P169	CONE NOSE ROPE SOCKET 15/32	0	OPTION
14	FSU2P162	SLIP 17/32 RELIABLE .470-.531 CABLE	0	
14	FSU2P163	SLIP 15/32 RELIABLE .392-.468 CABLE	0	OPTION
14	FSU2P164	SLIP 3/8 RELIABLE .325-.392 CABLE	0	OPTION
14	FSU2P165	SLIP 5/16 RELIABLE .270-.324 CABLE	0	OPTION
14	FSU2P170	SLIP 7/32 RELIABLE .215-.270 CABLE	0	OPTION
18	FSU2P143	WHEEL 6 X 2 PU AL CORE 900# 1/2+3/4 SHAFT	2	
20	FSU2M153	FRAME TENSION TEST 5K 12.5K# SLIP-TYPE	1	
21	FSU2M159	ADAPTER SLIP-TYPE TENS TST	2	
22	FSU2M162	CLEVIS CABLE HD THD TENS TST	1	
23	C276P242	SCREW 1/2-13 X 1-1/2 HEX HD SS	8	
24	FSU2P142	SCREW 1/2-13 X 4 HEX HD SST	3	
25	C276P017	NUT 1/2-13 ELASTIC STOP SST	10	
26	C276P037	WASHER 1/2 FLAT SST	20	
27	FSU2P116	ROD ALL-THREAD 1-1/4 - 12 GRB7 STL A193	18	
28	ALS1P017	CLAMP LOOP RUBBER CUSHION 3/4" ZINC PLATED	1	
30	AM3KP073	PIN QUICK REL 3/8 OD X 5 GRIP T-HANDLE W/RING SST	2	
31	FSU2P053	PIN QUICK REL 1/2 OD X 3 GRIP W/RING T-HANDLE SST	2	

### 3.4.6 FSU2A155 TENSION TEST STAND BILL OF MATERIALS continued

ITEM	P/N	DESCRIPTION	QTY.	REF
32	AM5KP080	SCREW 3/8-16 X 3/4 SOC HD SST	2	
33	AMS1P058	WASHER 3/8 LOCK SS	2	
34	C276P513	WASHER 3/8 FLAT SST	2	
35	AMS1P046	SCREW 5/16-18 X 1 SHCS SST	6	
36	C276P039	WASHER 5/16 FLAT SST	12	
37	AMS1P047	WASHER 5/16 LOCK SS	6	
38	AMS8P094	NUT 5/16-18 HEX SST	6	
39	AMS1P065	NUT 1/2-13 HEX SST	1	
40	C276P334	SCREW 10-32 X 1/2 PHIL PAN SST	4	
41	C276P035	WASHER #10 LOCK SS	4	
42	AMS1P054	WASHER #10 FLAT SS	4	
50	FSU1P037	ADPTR 3/8 NPT X #6 JIC 90 STL	1	
51	FSU1P036	ADPTR #6 SAE X #6 JIC STR STL	1	
52	FSU1M096-42	HOSE #6 JIC STR X 90 4KPSI WP 42" OAL	1	
54	FSU2P141	CPLG QD M 3/8NPT ENERPAC	1	
55	FSU2P101	OIL HYD ENERPAC	1	
61	FSU2P144	NUT 1-1/4-12 JAM HEX STL PL 7/16 THICK	1	
62	FSU2M146	PLATE CLAMP BALL VALVE	2	
63	FSU1P124	VALVE BALL 2-WAY SAE-06 HYDAC	1	

## 4.0 ALS8A TENSION PANEL



**ALS8A Tension Display Panel**

The ALS8A Tension Panel is a display panel used to in lbs (or kgs) the value of the sensor signal based on the defined load pin calibration. This value is then compared to a known verification value that is provided through the hand pump tension generator in the FSU2A1509 Tension Verification Stand.

The panel versions include:

100 – Is used on the master Calibration Load Cell.

101 – Passive for 2 mV/V Load Pins (passive, non-amplified Load Pins, and low-voltage amplified Load Pins).

102 – 0-1.5vdc Differential for 10k/5k Load Pins (Load Pins with amplified output).

120 – 4-20 mA Load Pins.

See each individual ALS8A panel Operating Manual for details.

The panel software includes a set up routine to provide the set-up of the panel to match the Load Pin used and the configuration of the measuring head. This introduces correction factors that then provide the adjustments to the Load Pin signal conversion.

The panel provides the required power for the Load Pin.

The Load Pin output is read off using a ALS8A Tension Display Panel. This panel has exactly the same circuitry as the logging panels and provides the excitation voltage to the Load Pin, as well as a conversion of the Load Pin output directly into lbs. tension.

\*NOTE – complete information on the ALS8A100, 101, 102, and 120 panels are in a separate manual.

The panel uses a 16-bit A/D for signal measurement. A fixed relationship provides a signal to read-out conversion, dependant on the set-up parameters and the setting point of the “ZERO”.

The “ZERO” button is used to negate any values when there is no load on the Load Pin, and provides a base point for further measurements.

Note that the panel includes linearity creation routine. The output of the Load Pin is not exactly linearly proportional to the applied load, but the panel software includes correction software that produces the linearity. For this reason the primary verification routine includes the linearity check.

Different connection cables are used between the panel and the load pin corresponding to the connector types used.

The panel indicates that power is attached with the EXT PWR LED on the front of the panel.

Selecting ENABLE on the front left panel toggle switch turns the panel on. Selecting OFF on the same toggle switch shuts the panel down.

The panel has a standby battery for loss of power. A fully charged battery should easily last several hours (depending on the type of Load Pin attached).

## 4.2 ALS8A SPECIFICATIONS

WEIGHT:	5 lbs	2.2 kgs
HEIGHT:	8.4”	0.25 m
WIDTH:	9.2”	0.35 m
DEPTH	4”	0.12 m
OPERATING VOLTAGE:	110 – 240 VAC	60/50 Hz
	12 – 24 VDC	
INPUT SIGNAL	100, 101	2MV/V
	110	0 – 1.5 VDC
	120	4 – 20 mA
DISPLAY:	6-figure HEXIDECIMAL	
SIGNAL COPY FUNCTION:	tension signal copy 0 – 1 mA	

#### **4.1 ALS8A TENSION PANEL OPERATING INSTRUCTIONS**

**1.** To set up the ALS8A panel for the head tester press the MENU button and select 'LC'.

The panel will briefly display the panel type and software revision level (e.g. 8A 102d), and will then display the Load Pin value corresponding to the existing Load Pin type attached to the panel.

Should the software require updating or renewing, please contact BenchMark technical support.

The panel will display then whatever value is associated with the load pin attached. If no load pin is attached, a spurious value will be displayed.

**2.** Press the MENU button and the panel will display the Line Size selection. Use the +/- switch to select from the menu choices (9/32", 7/32" 3/16", 5:16", 15/32", 15/32" with grooved wheel – "15d", 0.472", 0.472" with grooved wheel – "472d", 0.484", 0.492" and 17/32".

The line size affects the calculation of the load based on the effects of the line diameter on the measurement geometry compared to the calibration standard of 0.472" (Slammer) and 5/16" line.

**3.** Press the MENU button and the panel will display the Shunt value as read from the Load Pin. This is only applicable to load pins that have a Shunt reading.

**4.** Press the MENU button and the panel will allow the units to be toggles between lbs and kgs.

**5.** Press the MENU button and the panel will allow choice of either AM3K (= "3H") or AM5K (= "5H") measuring head. This also sets the default for Full Scale to 5,000 or 10,000 lbs respectively.

**6.** Press the MENU button and "ACCEPT" will be indicated. Use the +/- buttons to either accept "YES" the changes made, or "n0" reject the changes and revert to the earlier used parameters.

#### 4.2.1 ALS8A010-2 CABLE ASSEMBLY (LOAD CELL TO ALS8A100)

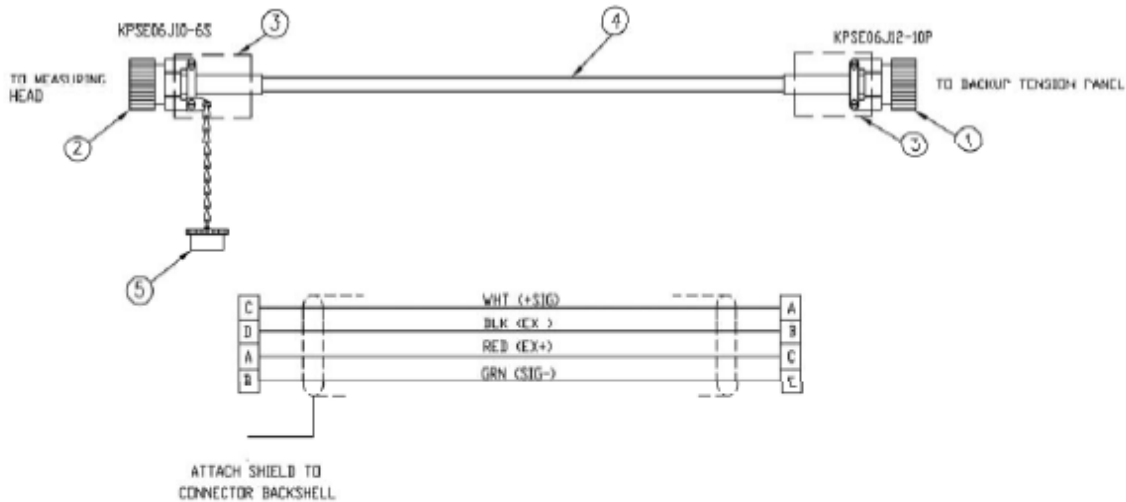

ITEM	P/N	DESCRIPTION	QTY	REF
1	AMS4P181	CONN KPSE06J12-10P STR PLUG	1 EA	TENSION PANEL END
2	AMS4P266	CONN KPSE06J10-6S STR PLUG	1 EA	LOAD CELL END
3	ACMU1P88	TUBING SHRINK 1.00 ADH LINED	1 EA	
4	AMS7P093	CABLE 22/2P BELDEN 8723	2 ft	

### 4.2.2 ALS8A012-5 CABLE ASSEMBLY (LOAD PIN TO ALS8A101 SECONDARY TENSION DISPLAY PANEL)

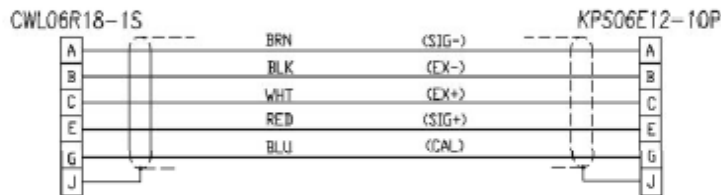
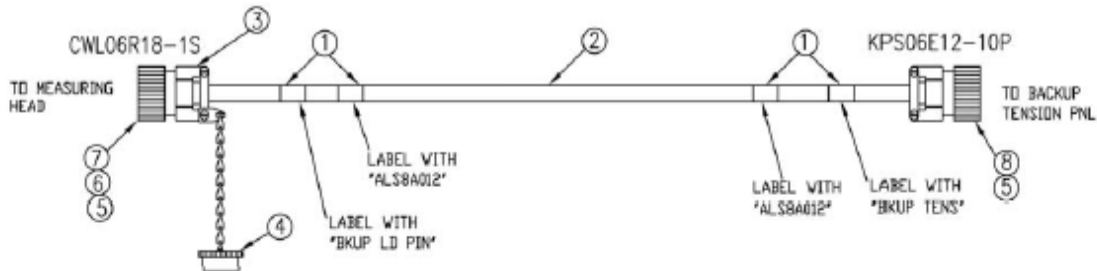

ITEM	P/N	DESCRIPTION	QTY
2	AMS4P965	CABLE SHIELDED 8C/20 AWG	5 FT
3	AMS1P130	CONN BACKSHELL RSI G61307-185	1 EA
4	AM5KP148	DUST PLUG CW50N16A CANNON CWL	1 EA
5	ACMU1P88	TUBING SHRINK 1.00 ADH LINED	2 EA
6	ACMU1P89	TUBING SHRINK 1.50 ADH LINED	1 EA
7	AM5KP146	CONN CWL06R18-1S CABLE PLUG	1 EA
8	AMS4P181	CONN KPSE06J12-10P STR PLUG	1 EA

### 4.2.3 AMS4A351-20 CABLE ASSEMBLY (LOAD PIN TO LOGGING SYSTEM)

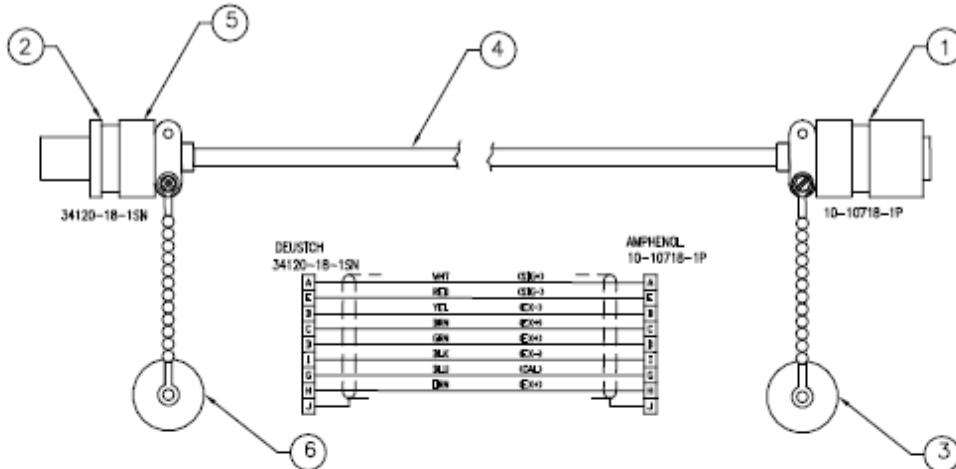

ITEM	P/N	DESCRIPTION	QTY
1	AM5KP146	CONN CWL06R18-1S CABLE PLUG	1 EA
2	AM5KP068	CONN 10-107218-1P BENDIX QWL	1 EA
3	AM5KP118	O-RING 2-023 BUNA N L/P CONN	1 EA
4	AMS1P056	WASHER #8 LOCK SST	4 EA
5	AMS4P982	CONN 10-107118-1P QWL STYLE	0 EA
6	C276P142	SCREW 8-32 X 1/2 PHIL PAN SST	4 EA
7	FSU2M018	ADAPTER CONN 1/2 NPT TO QWL18	1 EA
8	FSU2P027	CORDGRIP 1/2 NPT .25-.38ID	1 EA
9	AM5KP148	DUST PLUG CW50N16A CANNON CWL	0 EA
10	AMS4P221	CABLE 20/8C ALPHA 25468 BLACK	20 FT
11	AMS1P130	CONN BACKSHELL RSI G61307-185	1 EA
12	AMS4P985	DUST CAP 10-101063-18 QWL	0 EA



## 5.0 FURTHER TECHNICAL ASSISTANCE

Call BenchMark Wireline Products Inc.: +1.281.346 4300

Contact by email: [mail@benchmarkwireline.com](mailto:mail@benchmarkwireline.com)

Send a fax: +1.281.346 4301

Information is also available on website [www.benchmarkwireline.com](http://www.benchmarkwireline.com)

Parts can be ordered by email, phone, or fax.

### 5.1 EQUIPMENT RETURN

Equipment can be returned for calibration, repair and maintenance.

Please notify by phone, email, or fax (as above) prior to sending any equipment.

Return shipment address is:

BenchMark Wireline Products  
36220 FM 1093  
Simonton, Texas 77476  
U.S.A.

### 5.2 PRIMARY LOAD CELL CALIBRATION PROCEDURE

The primary load cell can be returned to BenchMark to be recalibrated. Use BenchMark part number FSU2P125-CAL to perform this service.

A new primary load cell can be ordered from BenchMark using part number FSU2P125.

## APPENDIX 1

### LINE TENSION MEASUREMENT OVERVIEW

Line tension is usually derived from surface hydraulic or electric measurements based on some sort of compression or tensional force. Only down hole devices have the ability to measure the line tension (at the cable head) directly.

In many slickline applications measurements are hydraulically derived. Electrically derived measurements are more often used in electrical wireline rig-ups.

While the hydraulic measurements are often sufficiently accurate for day-to-day operations, they are subject to temperature drift, and are susceptible to inaccuracies related to the maintenance of the hydraulic system and the usually associated mechanical instrumentation. A common source of error is remnant air in the hydraulic lines or bellows. Also, depending on the rig up arrangement hydraulic systems may lack response precision and resolution. Nevertheless, they are easy to use, inexpensive, robust and usually suitable for use in hazardous environments.

Electrical measurements using either tensile load pins, strain gauges or load cells are reliable and, when correctly calibrated, accurate. Also, electrical measurements provide a high dynamic range, fast response and high resolution. They are, however, prone to problems particularly if the connectors and connection cables are not well maintained. Electrical equipment must be certified (typically Ex certified) if used in hazardous environments.

Line tension is a key input to all wireline operations, and a major safety factor in day-to-day work. Also, line tension is used in providing corrections to depth, and in line length and measuring head calibration operations. Accurate and reliable knowledge of line tension is a given requirement.

There are three main types of line tension measurement arrangements (see Figure 4) :

Measure head tension - This uses either deflected line in a feed-through or a wrap-around type tension measurement device.

Lower sheave wheel (hay pulley) tension. The restraining force that the lower sheave wheel is subject to represents the line tension.

Upper sheave wheel (top hay pulley) tension. This tension measurement is typically applied used with multi-conductor wireline. Usually this is an electrical measurement.

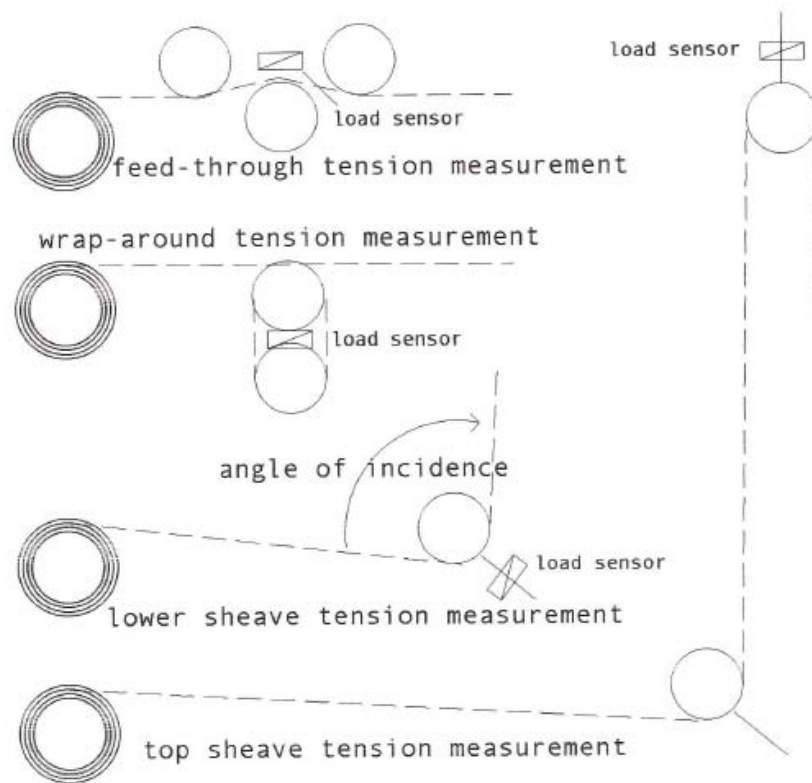

### Types of Line Tension Measurement Systems

Using lower sheave wheel derived tension requires correction for the angle of incidence of the line. Correction for this angle is known as K-factor. An incorrect K-factor will result in an incorrect tension value being arrived at. In some devices the display scaling assumes a nominal (90°) angle. Other devices require the angle to be given. In any case, K-factor is one of the most significant sources of tension measurement error.

Another complication to the use of the lower sheave for tension is that as tension increases the lower sheave wheel moves up, causing the line incidence angle to change, and hence also the K-factor.

K-factor is defined by the following equation:

$$K - \text{factor} = \frac{1}{\frac{2 \times \cos \theta}{2}}$$

where  $\theta$  = angle of incidence

and **Actual line tension = Sheave wheel force x K - factor**

Typical K-factors are given in the table below:

$\theta$	0°	60°	90°	120°
K-factor	0.500	0.577	0.707	1.000
application	open hole, top sheave	short rig-up, lower sheave	ideal rig-up, lower sheave	High angle rig-up Lower sheave

## APPENDIX 2 TENSION DEVICES

Most types of tension measurement devices use a single (or double) Wheatstone bridge circuit that provides a signal that is internally amplified and made available as an output signal. Deformation of one or more of the resistance circuits in the bridge causes a change to the electrical characteristics of the circuit that is then related to the load applied.

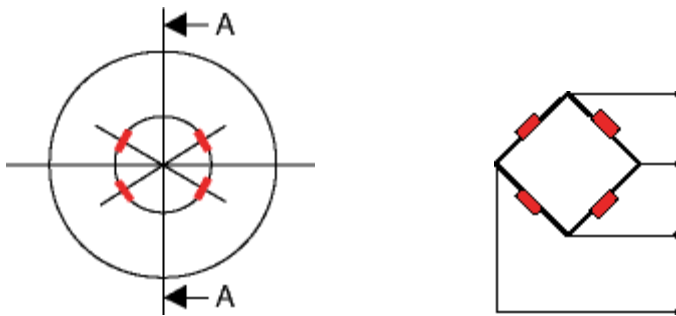

**Wheatstone Bridge in Load Measurements**

The calibration process measures and records the output of the circuitry to known and defined loads.

### LOAD PIN

In a load pin, the axial stress on a load pin axle is measured, and the geometric arrangement of the pin assembly gives rise to the measurement, typically with a Wheatstone bridge.

### MEASUREMENT PRINCIPLE

The load operates on shear force across the load pin shaft. The deformation is proportional to the load. This deformation is measured using a strain gauge Wheatstone bridge integrated in the pin. When force is applied to the load measuring pin along its sensitive axis, the effect on the strain gauge bridge results in an output signal proportional to the applied force.

The powering of the strain gauge bridge is provided externally and the output of the bridge is proportional to the "excitation voltage provided, as  $mV/V$ . Sometimes this signal is internally amplified before being made available. Other times the output is converted to a 4 – 20 mA signal.

Depending on the type of pin, the circuitry may also be equipped with a calibration circuit (shunt signal) that provides a fixed signal that can be adjusted to match the output of the pin for given loads. This allows a standard signal to be provided against which the instrument reading can be matched.

Before load is applied

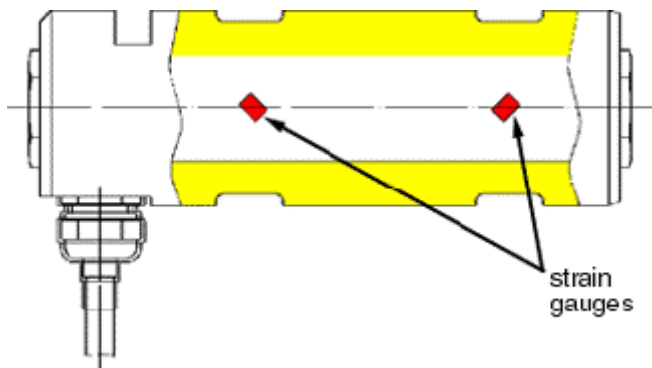

After - the load is proportional to the signal

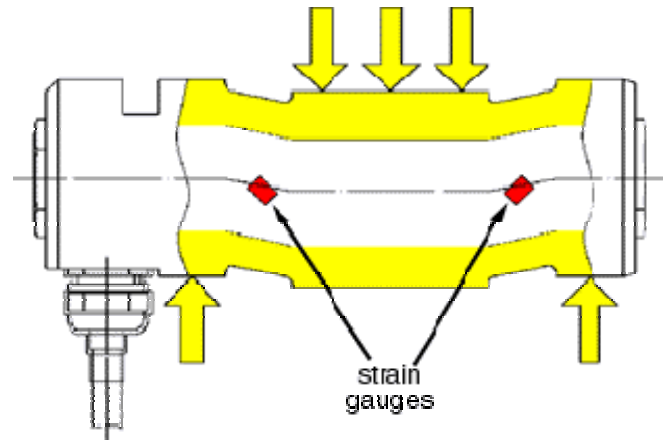

### Load Pin Deformation Using Wheatstone Bridge Measurement

#### LOAD PIN DEVICES

Load pins are used in a number of BenchMark devices.

The load pin serves as the axle for a measurement wheel which is subject to an increasing axial load as the line tension increases. The higher the line load, the greater the force exerted by the measure wheel on the load pin axle. The calibration for the measurement must take into account the following:

- The distance between the load cell measure wheel and the adjacent support wheels,
- The offset to the line caused by the measure wheel,
- Line diameter.

Errors may occur if the measure wheel or support wheels are damaged or work, or if the movement of the wheels is in any way hindered.

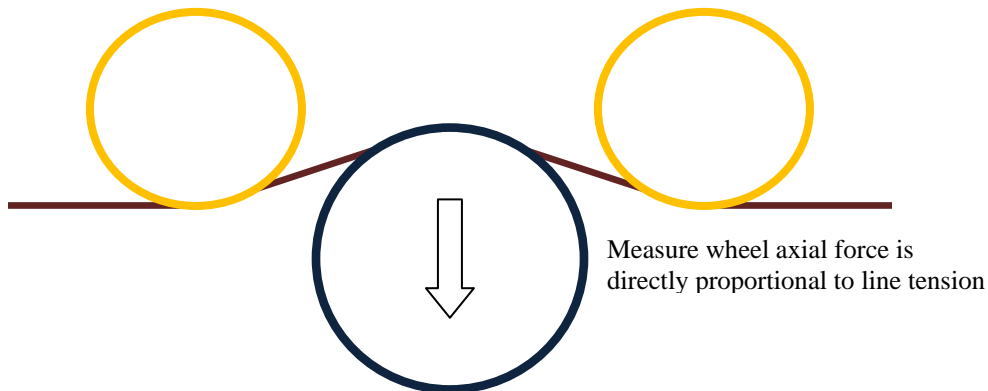

### Deflection Measurement of Tension with Load Pin Devices

In this case, the tension in the wireline is deflected into a horizontal and vertical component on each side of the wheel such that the resulting force on the measure wheel load pin can be expressed as:



$$pin\ force = 2 \times \sin\theta \times line\ tension$$

### Resolution of Forces in Deflection Measurement

For any given measure wheel configuration, given the same wireline and exactly the same mechanical dimensions (assuming no wear or irregularity), the measure pin response will be equally proportional to the line tension.

Note that the wireline size affects the geometry of the measurement (because of the affect on the angle  $\theta$ ). As such, the tension measurement will vary according to the wireline OD used. Hence any particular calibration is only valid for a particular wireline size. Also, as the wireline is compressed (as may happen at higher tensions), the effective diameter can be marginally reduced, again causing an effect on the measured signal.

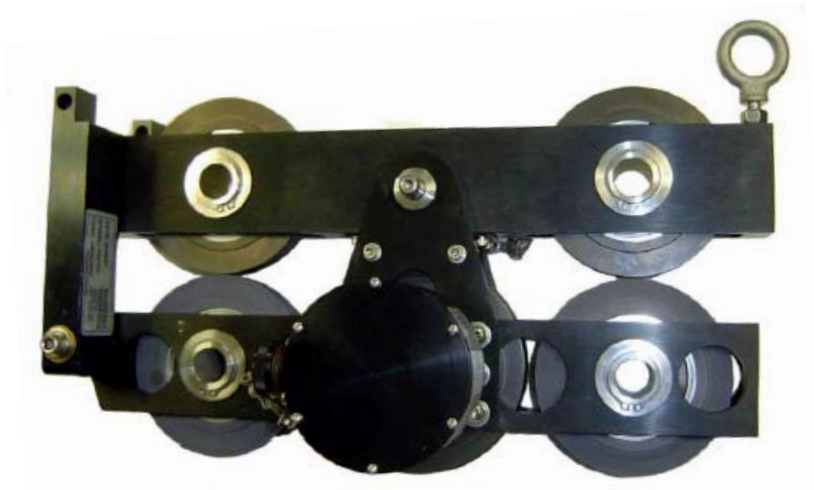

**AMTKA519B In-Line Tension Device**



**AM5K Open/Cased Hole Measuring Head**



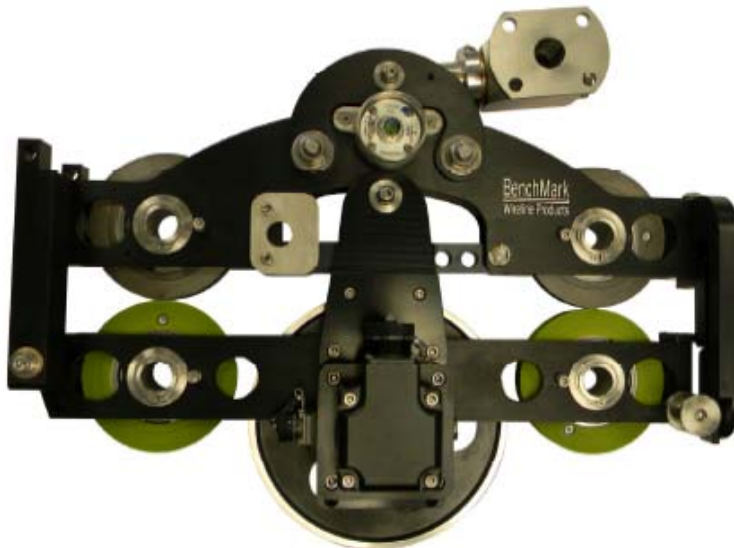

**AM3K Cased Hole Measuring Head**

## LOAD PIN WRAP-AROUND DEVICES

Load pins are also used in wrap-around devices, where the line tension factor x 2 of the measured force due to the opposing forces on the measure wheel. Examples of this are Megamouth and Shark slickline measuring heads. Note that in this case the line does not have to enter and leave the measuring head at the same angle, as the line tension being measured at the measure wheel is independent of the entry and exit angles of the line at the support wheel.

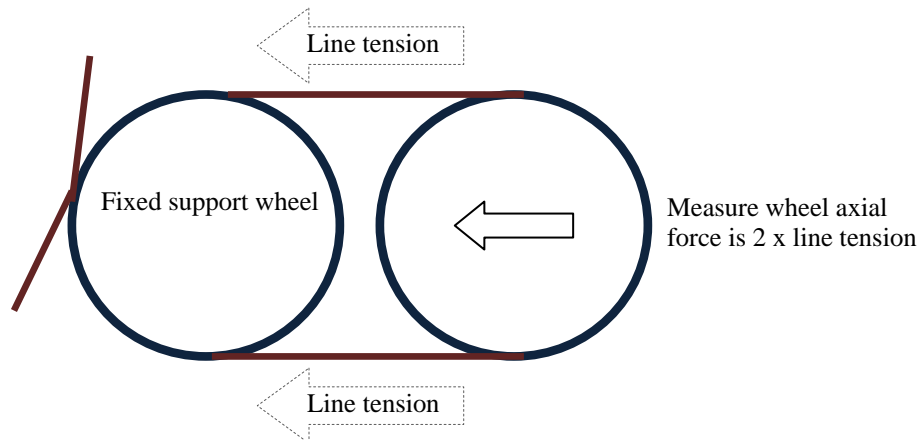

**Wrap Around Measurement of Tension with Load Pin Devices**

In this case, the load pin is subject to a force equal to twice the line tension, and is independent of line size. The load pin must be removed from the slickline. A special plate and a two piece cable are needed to test the load pin. One of the cables is connected to the top of the calibrator and the other to the bottom. The plate is connected to the cables and the load pin inserted into the plate.

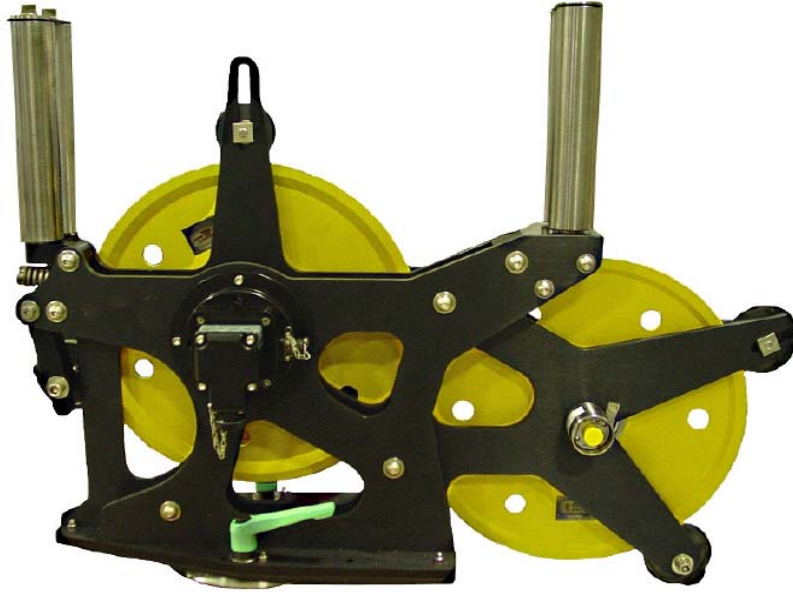

**Megamouth Slickline/Braided Line Measuring Head**

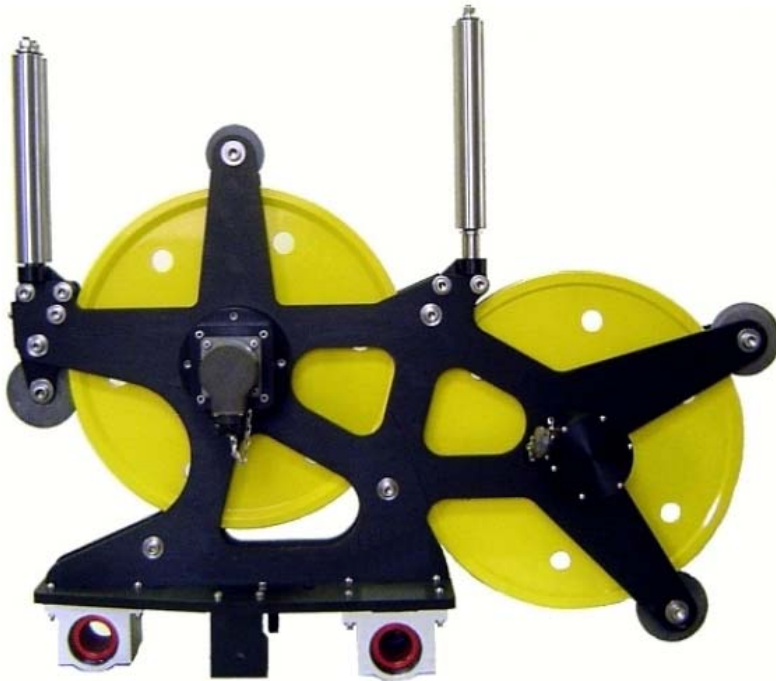

**Shark Slickline/Braided Line Measuring Head**

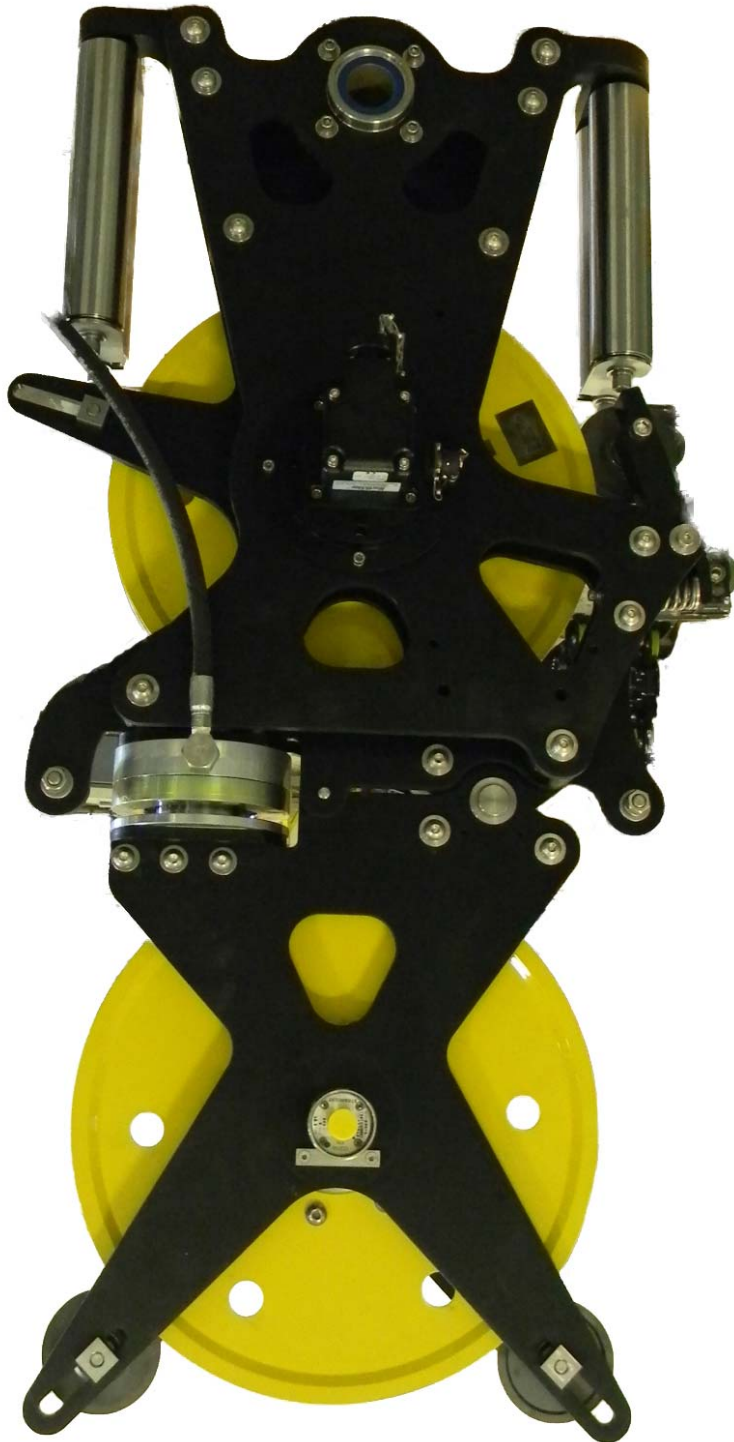

**Dolphin Slickline/Braided Line Measuring Head**